

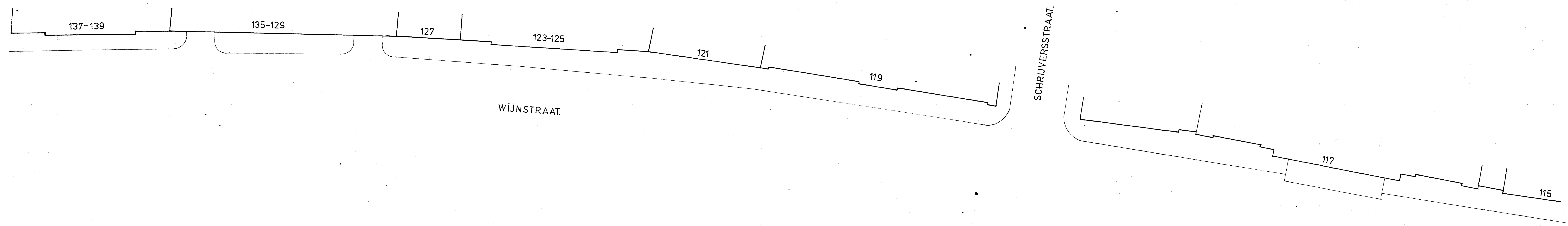

NAP



gemeente dordrecht	get. RB.	10-3-75
openbare werken en stadsontwikkeling	gez.	
afd. monumentenzorg		
onderwerp: STRAATWANDEN	gew.	1:100
omschrijving: WIJNSTRAAT 117 t/m 139	bijbehorende tek.	formaat: 80x26
	tekeningnummer:	R 382-10



NAP

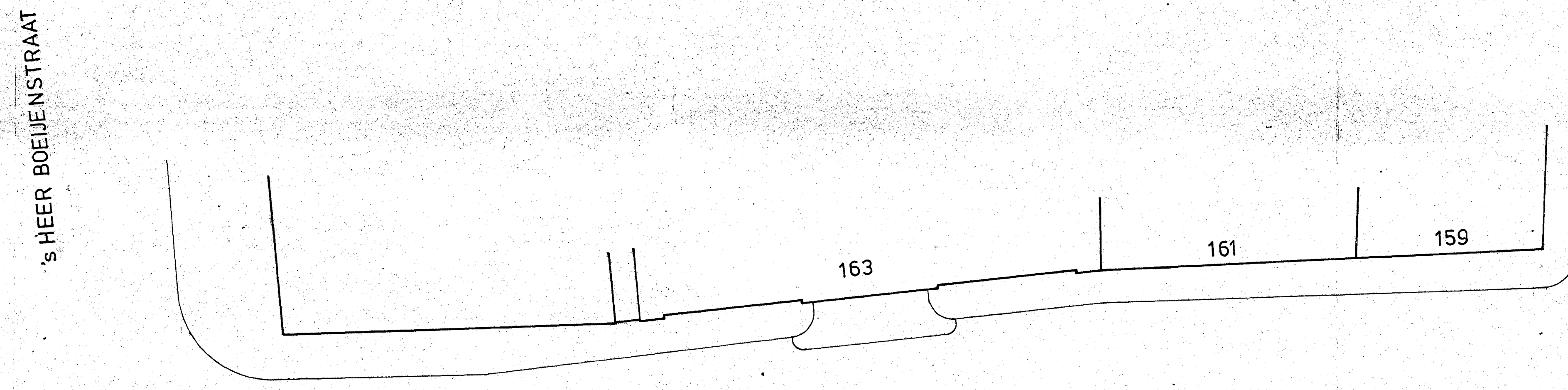
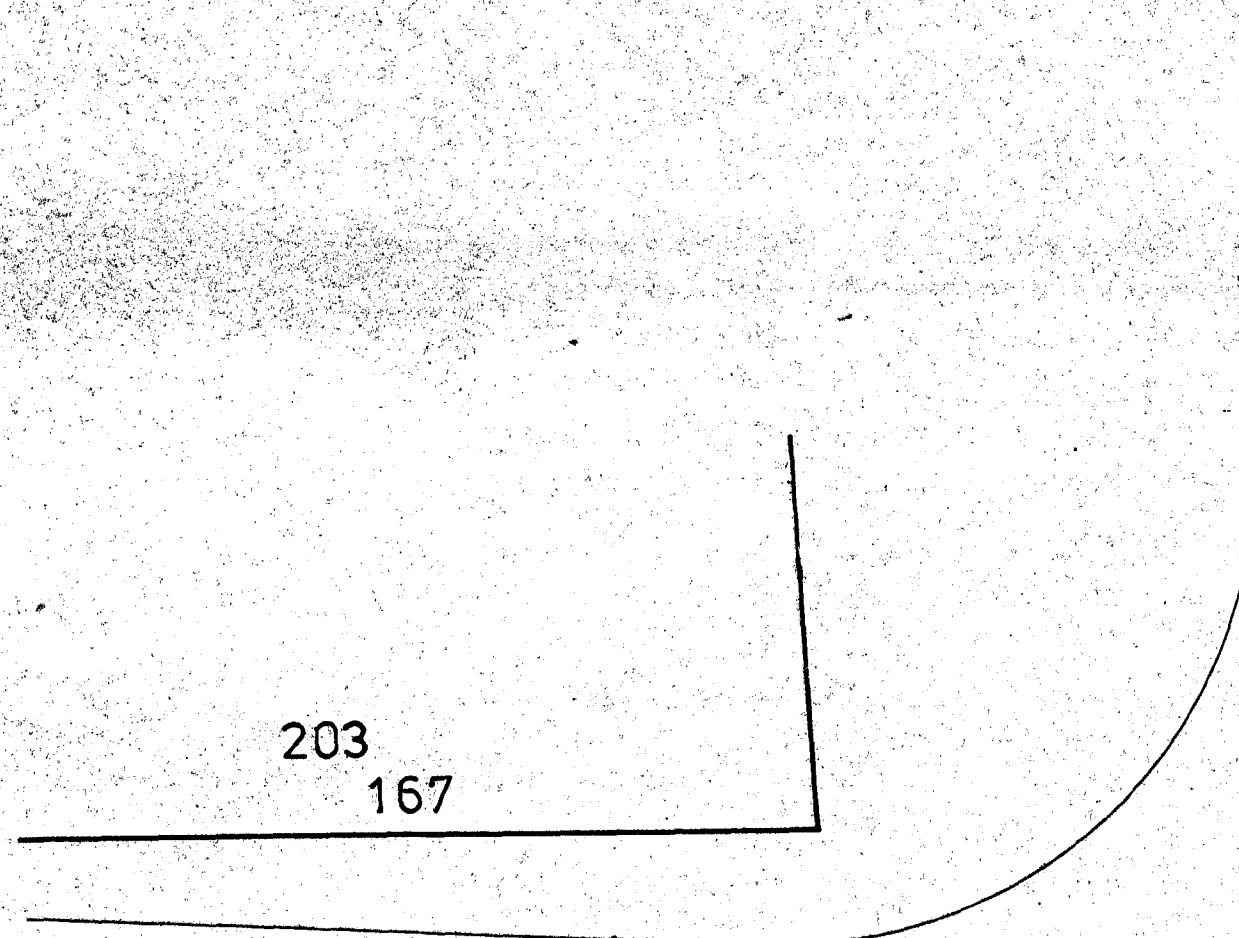

GRAVENSTRAAT.

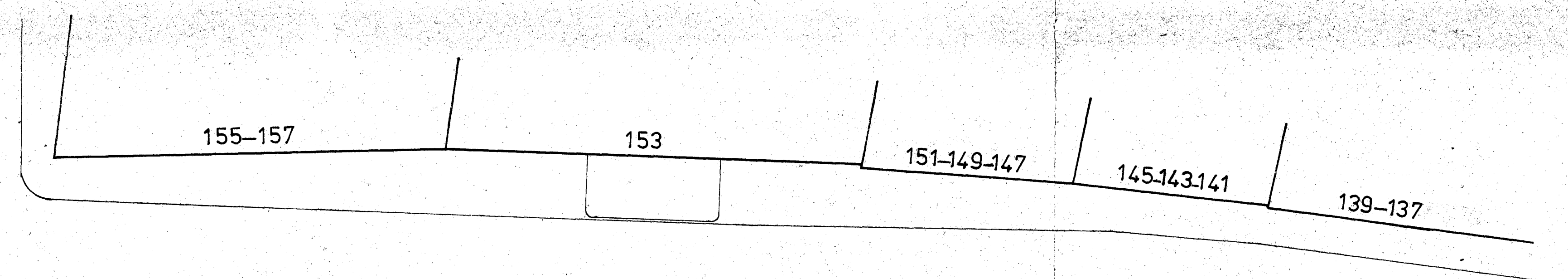

22 OKT. 1976

gemeente dordrecht		get. RB.KW	14-3-75
openbare werken en stadsontwikkeling		gez.	
afd. monumentenzorg		gew.	
onderwerp	STRAATWANDEN.	bijbehorende tek.	schaal: 1:100
omschrijving	WIJNSTRAAT 137tm167	tekeningnummer	80126
			R 382-8

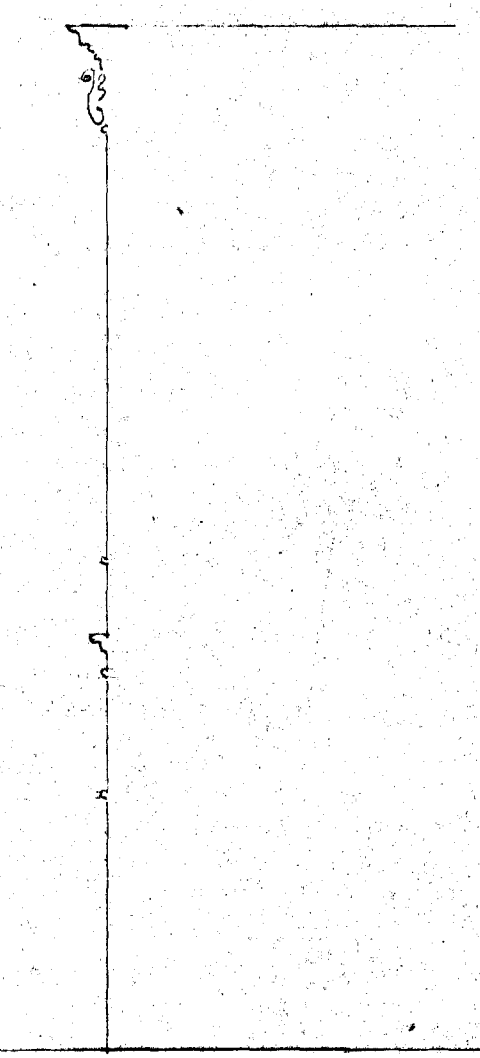

NIEUW BRUG

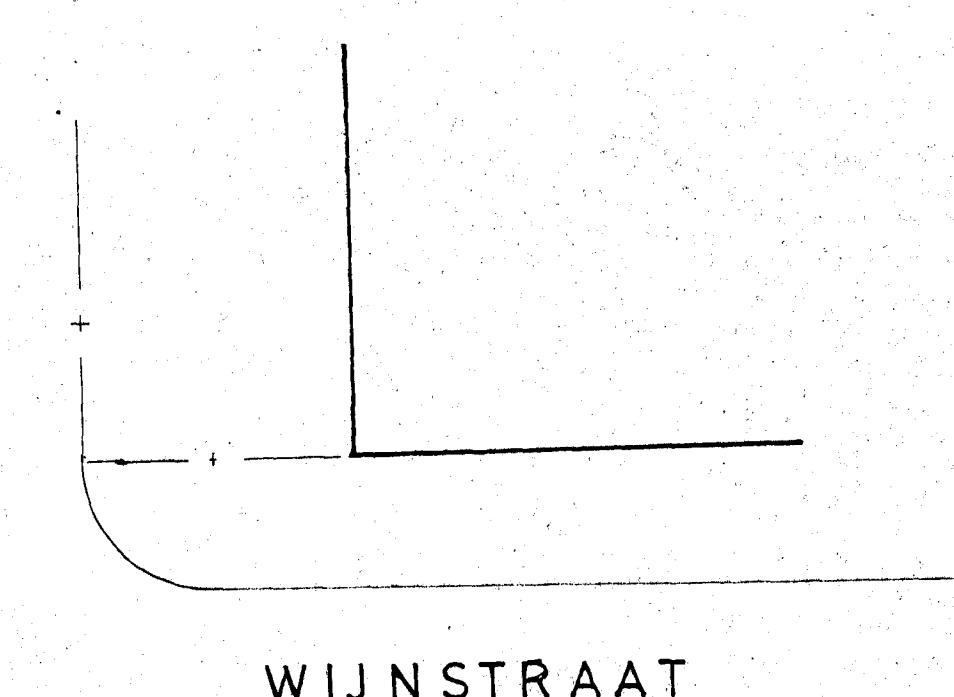
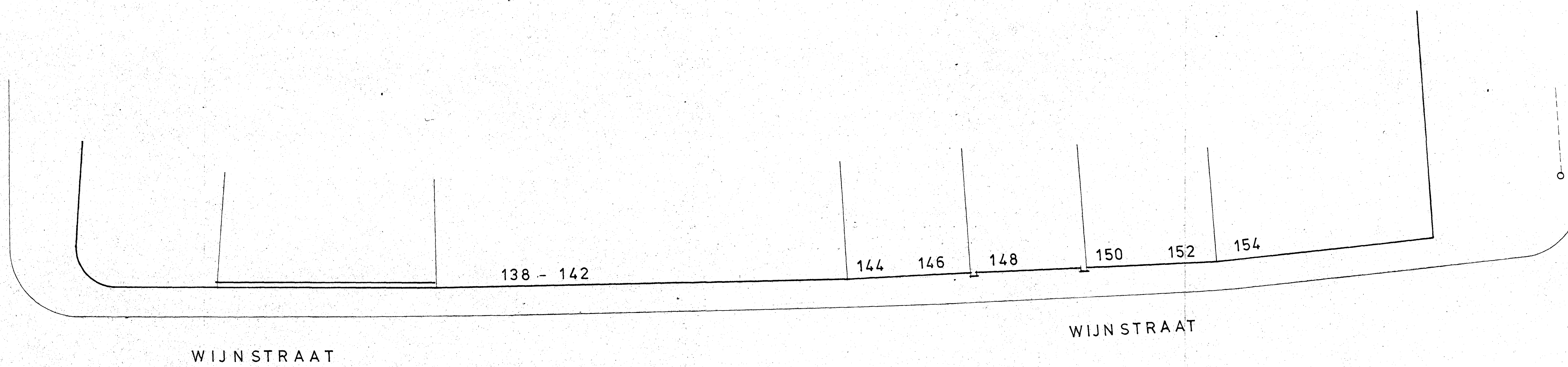

WIJNSTRAAT

22 OKT. 1976

gemeente dordrecht		get. <i>KZ</i>	04 03 75
openbare werken en stadsontwikkeling		gez.	
afd. monumentenzorg		gez.	
onderwerp	straatwanden		gew.
omschrijving	WIJNSTRAAT 138 t/m 154	bijbehorende tek.	schaal: 1:100
		tekeningnummer	formaat: 80x126
			R 382-9



NAP

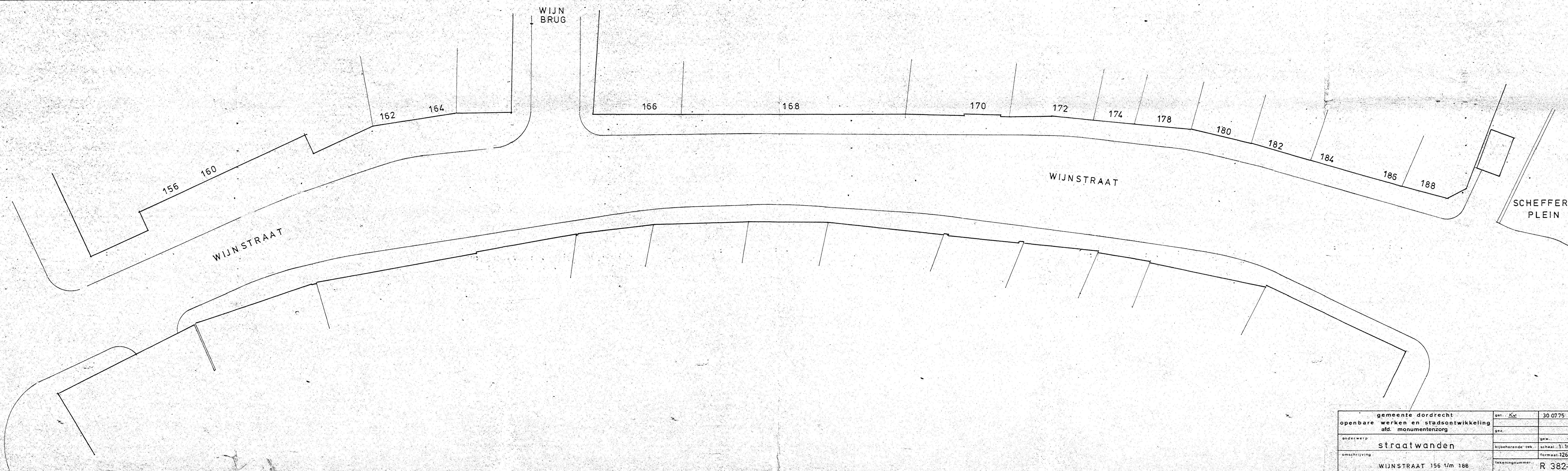

gemeente dordrecht		get. K. v. v.	30 0775
openbare werken en stadsontwikkeling		gez.	
ad. monumentenzorg		gew.	
onderwerp	straatwanden	bijbehorende tek.	schaal: 1:100
omschrijving	WIJNSTRAAT 156 t/m 188	formaat: 126x80	
		tekeningnummer	R 382-20



N.A.P.

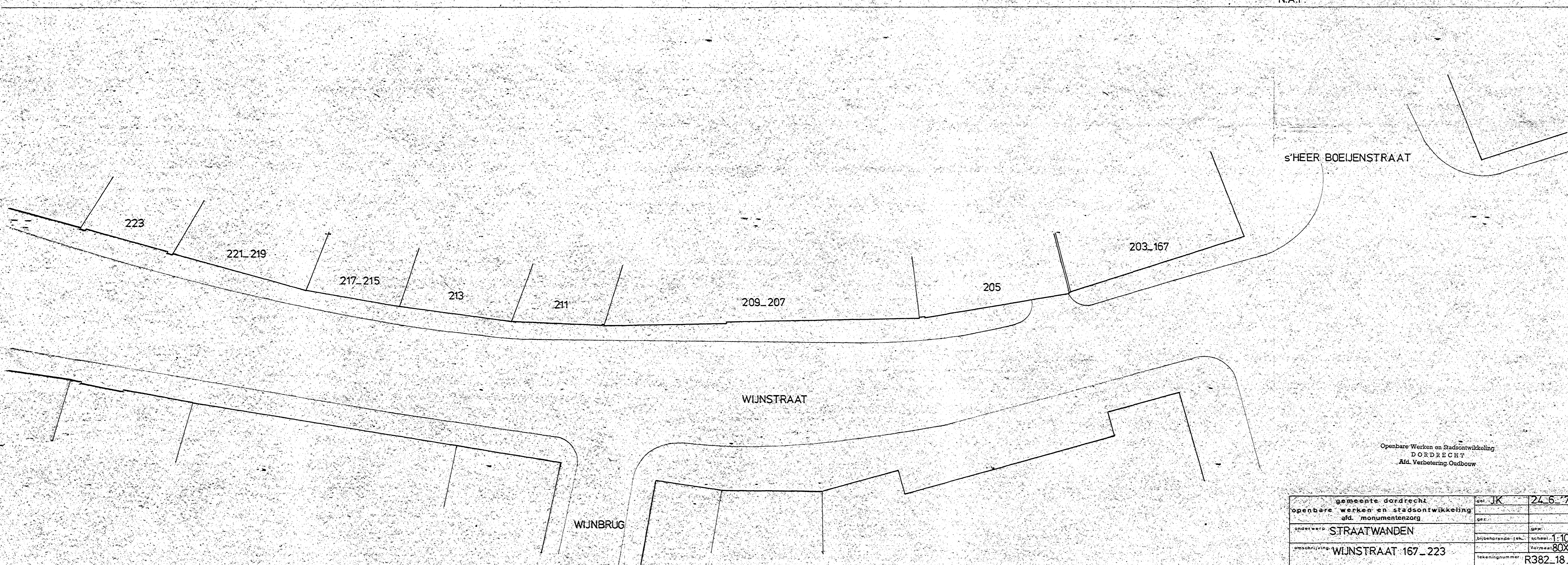

S'HEER BOEIJENSTRAAT

WIJNSTRAAT

WIJNBRUG

223

221\_219

217\_215

213

211

209\_207

205

203\_167

Openbare Werken en Stadsontwikkeling  
DORDRECHT  
Afd. Verbetering-Oudbouw

gemeente dordrecht	get. JK	24.6.75
openbare werken en stadsontwikkeling	get. 1	
afd. monumentenzorg	get. 1	
onderwerp STRAATWANDEN	get. 1	
omschrijving WIJNSTRAAT 167_223	schaal 1:100	formaat 80x105
	tekeningnummer	R382_18.

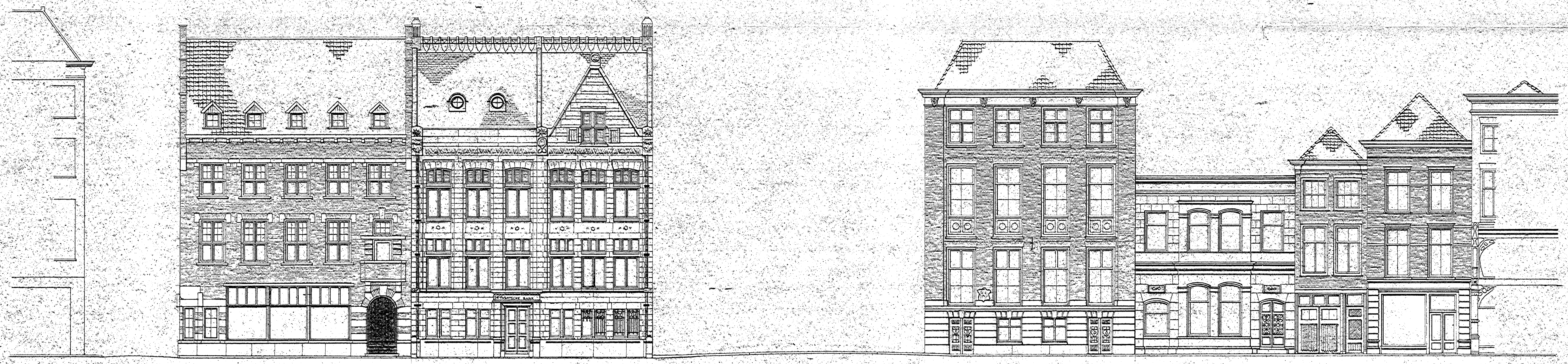

N.A.P.

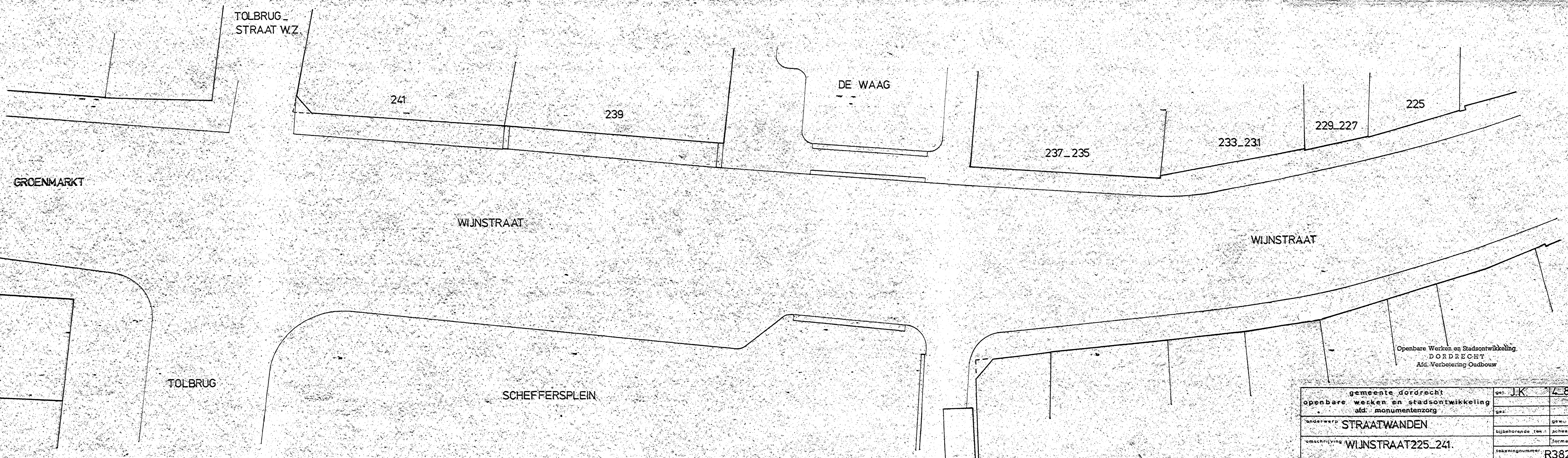

Openbare Werken en Stadsontwikkeling  
DORDRECHT  
Afd. Verbetering Oudbouw

gemeente dordrecht		get. J.K.	4-8-75
openbare werken en stadsontwikkeling		get.	
afd. monumentenzorg		get.	
onderwerp	STRAATWANDEN	get.	
omschrijving	WIJNSTRAAT 225-241.	bijbehorende teek.	schaal: 1:100
		tekeningnummer	30x105
			R382-19

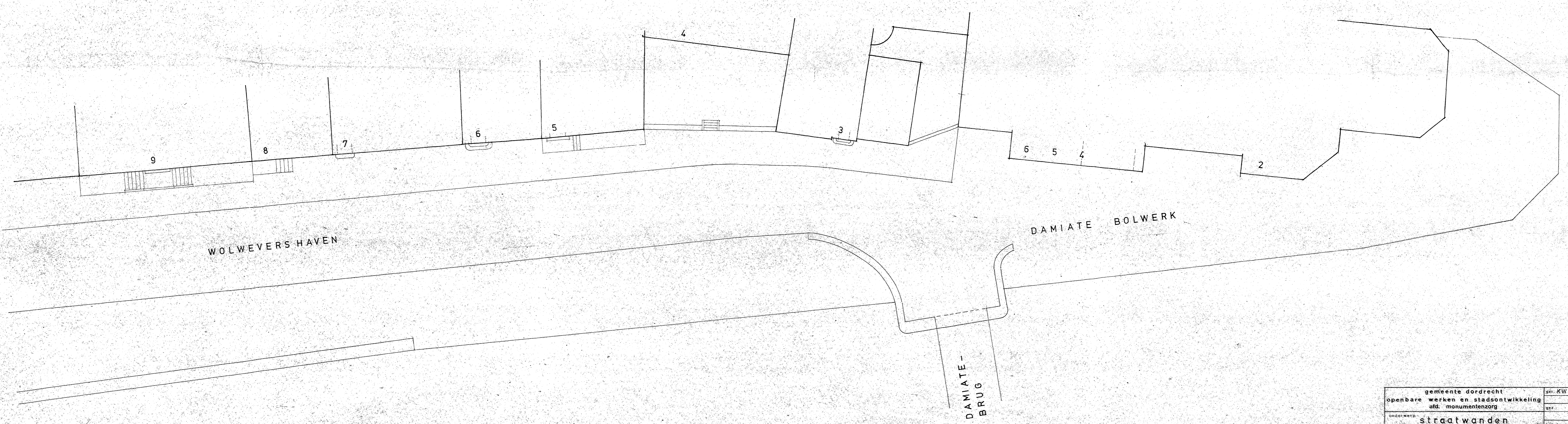

4 MAART 1977

gemeente dordrecht		gd. KW	18.02.77
openbare werken en stadsontwikkeling		vez.	
afd. monumentenzorg		gew.	
<b>straatwanden</b>			
DAMIATE BOLWERK 2 f/m 6		bijbehorende tek.	schaal: 1:100
WOLWEVERSHAVEN 3 f/m 9		tekeningnummer	formaat: 80x126
			R 382 83

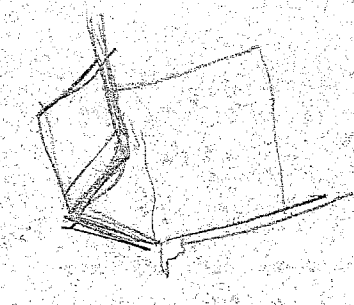

NAP

NAP

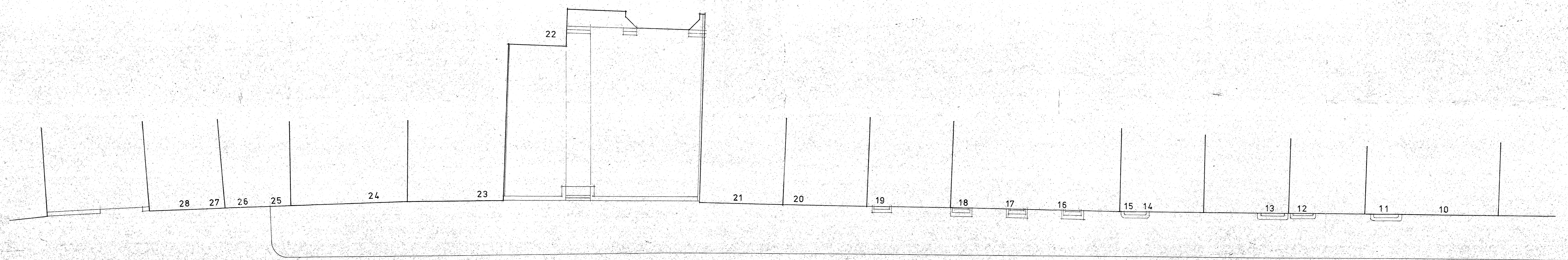

WOLWEVERS HAVEN

WOLWEVERS HAVEN

gemeente dordrecht	van: KW	21.01.77
openbare werken en stadsontwikkeling	gev.	
afd. monumentenzorg	gev.	
<b>straatwanden</b>		
omschrijving	bijbehorende tek.	schaal: 1:100
WOLWEVERSHAVEN 10 t/m 28		formaat: 60 x 126
tekeningnummer	R 382-84	





NAP

NAP

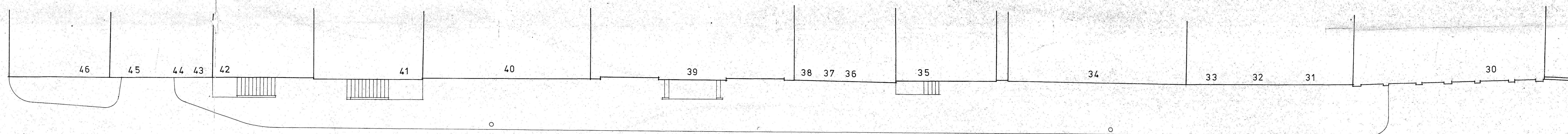

WOLWEVERS HAVEN

WOLWEVERS HAVEN

V L A K

gemeente dordrecht		get. KW	28 12 76
openbare werken en stadsontwikkeling		gez.	
afd. monumentenzorg		gew.	
onderwerp	straatwanden	bijbehorende tek.	schaal. 1:100
omschrijving	WOLWEVERS HAVEN 30 t/m 46	tekeningnummer	formaat 89 x 120
			R 382-85

Openbare Werken en Stadsontwikkeling  
DORDRECHT  
Verbetering Oudbouw

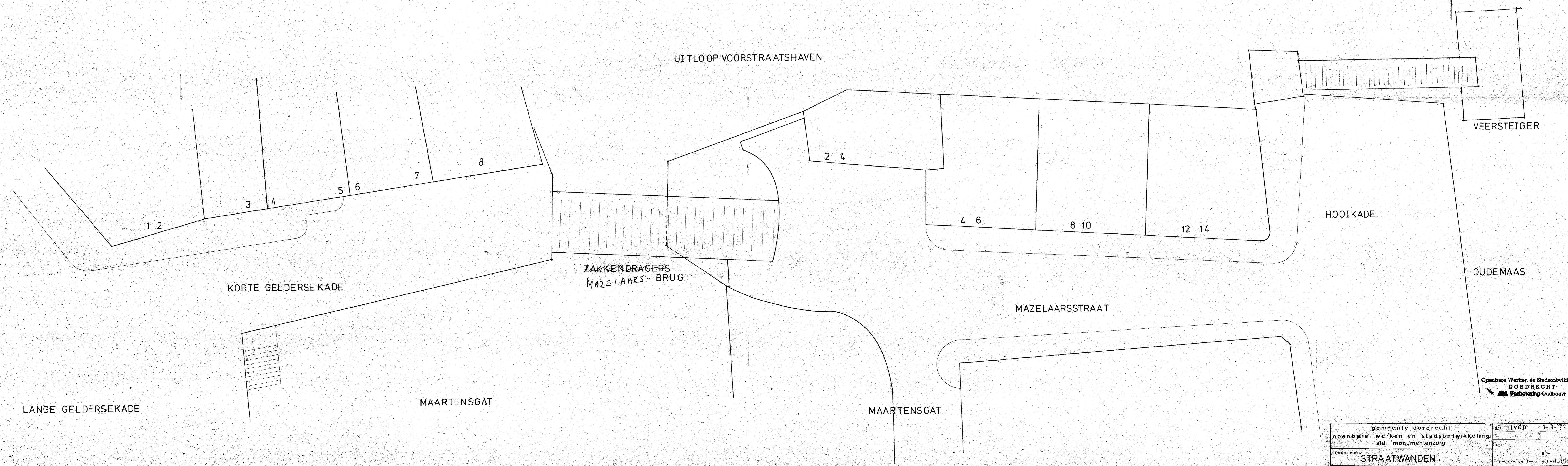
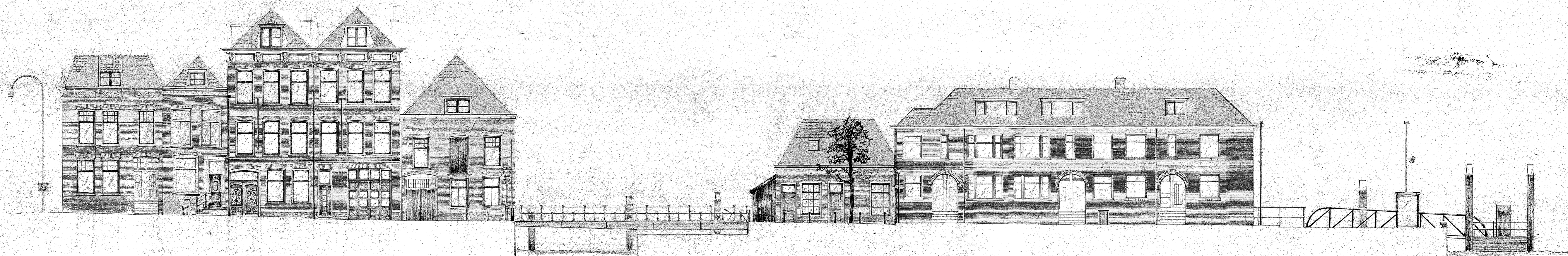

Openbare Werken en Stadsontwikkeling  
**DORDRECHT**  
 afd. Verbetering Oudbouw

gemeente dordrecht		get. jvdp	1-3-77
openbare werken en stadsontwikkeling		geo.	
afd. monumentenzorg		sch.	
<b>STRAATWANDEN</b>		afgeleide tek.	schaal: 1:100
korte gelderse kade: 1-8		formaat:	80x126
zakkendragersbrug			
mazelaarsstraat: 2-14		tekeningnummer	R 382 108